

www.miannebenchwork.com

MIANNE Customizable Benchwork

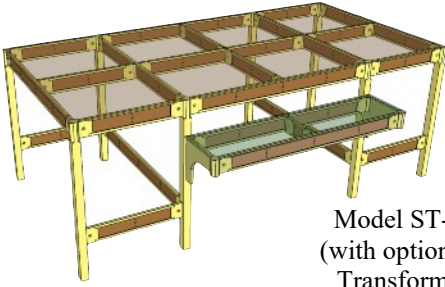

\$3.00 *The Fast Track to Layout Construction* Volume 29 Number 1



Model ST-4X8TSR (with optional TS-48F Transformer Shelf)

2026



Big or small, we build them all!

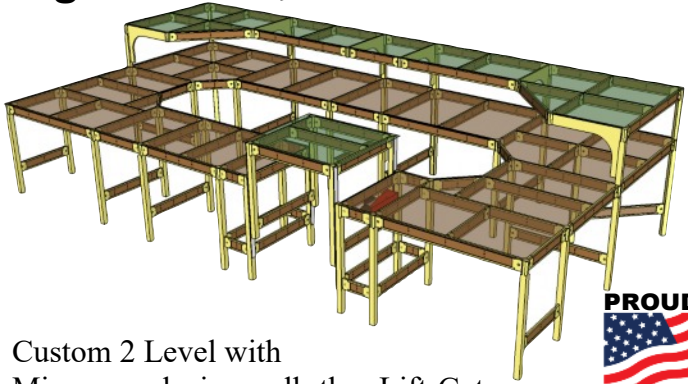

Custom 2 Level with Mianne exclusive walk-thru Lift-Gate



STEP UP TO THE BEST ENGINEERED, EASIEST TO USE AND MOST COMPLETE BENCHWORK SYSTEM IN THE WORLD

The best layouts start with the best benchwork



© 2025 Mianne Foley Woodworking Inc,
44A Union St. Attleboro, MA 02703
(508) 226-1600 fax (508) 226-1666
miannebenchwork@gmail.com

This open grid style benchwork is ideal for all sizes and gauges of layouts. It will save you both time and money.

There is no longer any reason to spend valuable hobby hours figuring, selecting and cutting materials.

You can assemble your own custom MIANNE bench quickly with only a few hand tools.

Rectangular Starter Kits

Traditional rectangular shaped layouts that are great for any size room. These kits are a perfect starting point for the beginning modeler or seasoned veteran that wants something to get the trains up and running. As the focus of your railroad changes these kits can be expanded or disassembled and reassembled into your dream layout.

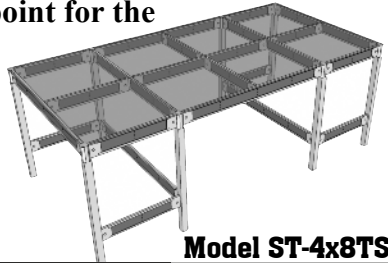

Model ST-4x8TSR

Size (Model #)	Price	Size (Model #)	Price
ST-2 x 6TSR	\$295.00	ST-5 x 8TSR	\$569.00
ST-2 x 8TSR	419.00	ST-5 x 9TSR	719.00
ST-3 x 8TSR	445.00	ST-5 x 10TSR	749.00
ST-3 x 10TSR	499.00	ST-5 x 12TSR	799.00
ST- 3 x 12TSR	519.00	ST-5 x 16TSR	999.00
ST-4 x 6TSR	399.00	ST-6 x 8TSR	669.00
ST-4 x 8TSR	519.00	ST-6 x 9TSR	739.00
ST-4 x 9TSR	549.00	ST-6 x 10TSR	849.00
ST-4 x 10TSR	579.00	ST-6 x 12TSR	939.00
ST-4 x 12TSR	729.00	ST-6 x 16TSR	1259.00
ST-4 x 16TSR	919.00	ST-8 x 8TSR	889.00

Don't see a size that works for you? Give us a call and we'll design a kit just for you. There are no extra charges for custom sized kits, we just want to make sure we sell you what you need to get your trains out of the boxes and on the tracks. Incremental changes of 6" in any direction require no custom parts. Above prices based on standard 40" height or lower.

Mianne Classic Layouts

As low as
\$569.00

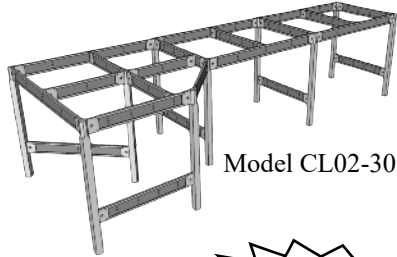
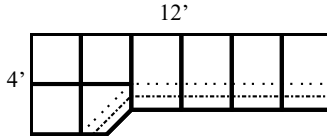

Model CL02-30 shown

Models CL02-24.....\$569.00
 CL02-30.....589.00
 CL02-36.....609.00
 4' x 12' x 40" high

As low as
\$689.00

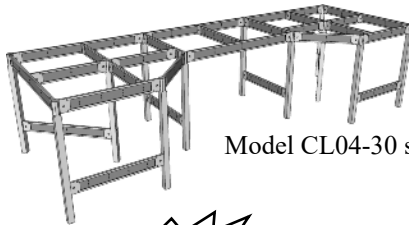
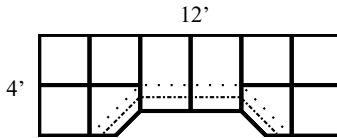

Model CL04-30 shown

Models CL04-24.....\$689.00
 CL04-30.....709.00
 CL04-36.....729.00
 4' x 12' x 40" high

As low as
\$819.00

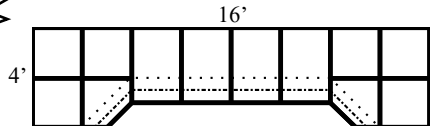

Models CL09-24.....\$819.00
 CL09-30.....839.00
 CL09-36.....869.00
 4' x 16' x 40" high

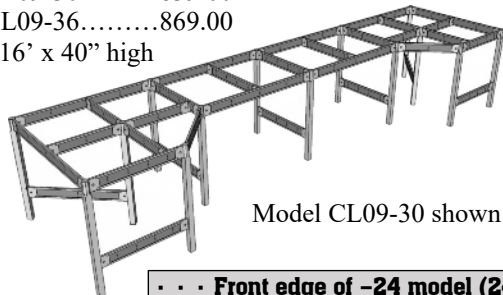

Model CL09-30 shown

••• Front edge of -24 model (24")
 - - - Front edge of -30 model (30")

"I was able to change the configuration of the layout in minutes, making better use of the space in the room (my wife thanks you). Me? I get to try out another track-plan. Great product."
Steve R.

"With easy to follow color coded diagrams, assembly was very enjoyable. Assembly was easy and the hardware was top notch. About 12 hours later, we had the 28'x20' layout complete and level. Every stick was perfect out of the box and the fit was exact. The light weight construction was super strong."
Al Z.

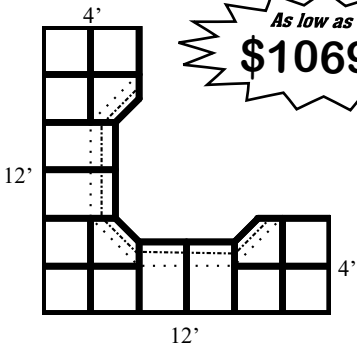

As low as
\$1069.00

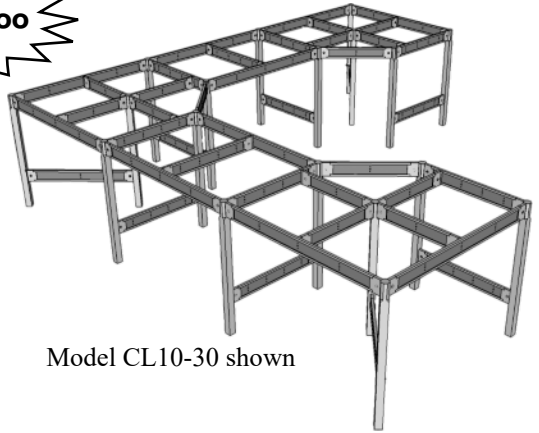

Model CL10-30 shown

Models CL10-24.....\$1069.00
 CL10-30.....1089.00
 CL10-36.....1119.00
 4' x 12' x 12' x 40" high

As low as
\$1199.00

Models CL06-24.....\$1199.00
 CL06-30.....1219.00
 CL06-36.....1259.00
 4' x 12' x 16' x 40" high

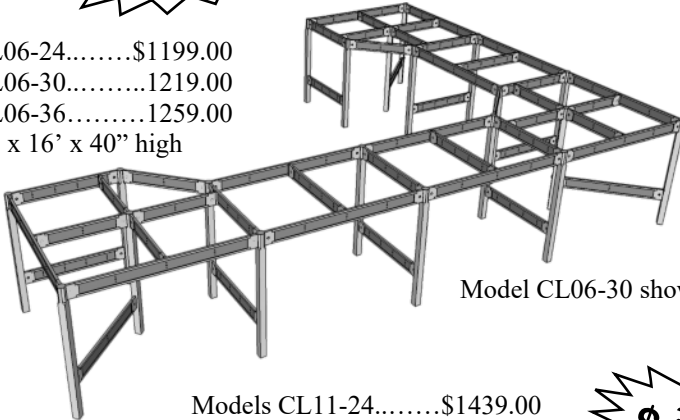
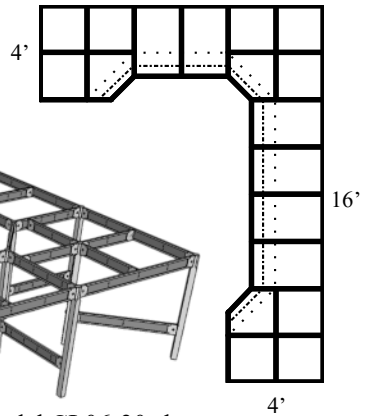

Model CL06-30 shown

Models CL11-24.....\$1439.00
 CL11-30.....1479.00
 CL11-36.....1519.00
 4' x 12' x 12' x 40" high

As low as
\$1439.00

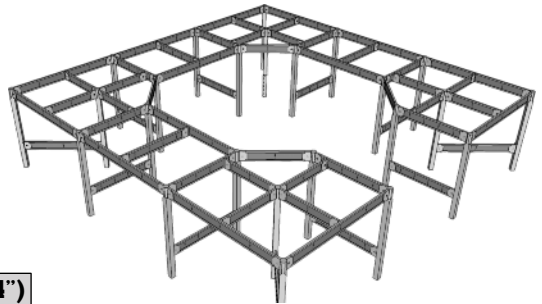
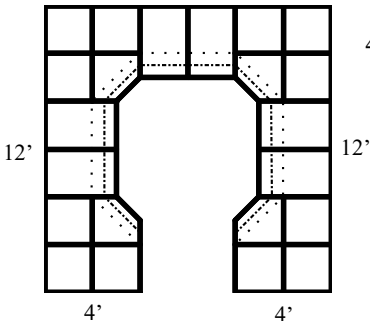

Model CL11-30 shown

· · · Front edge of -24 model (24")
 - - - Front edge of -30 model (30")

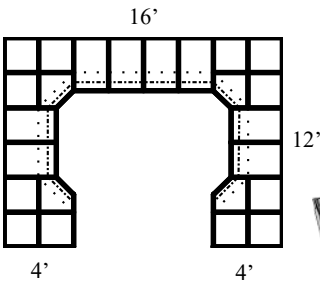

As low as
\$1579.00

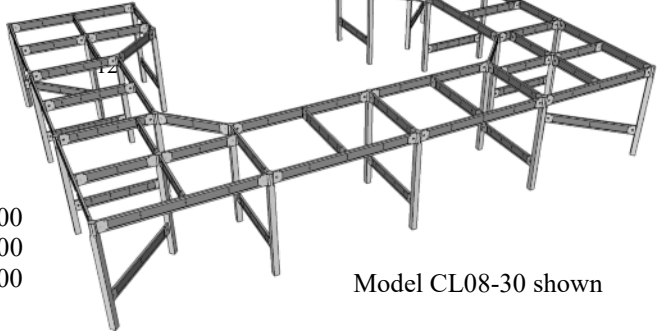

Model CL08-30 shown

Models CL08-24.....\$1579.00
 CL08-30.....1599.00
 CL08-36.....1659.00
 4' x 12' x 16' x 40" high

Mianne Walk-Thru Layouts

Around the room style with easy interior access

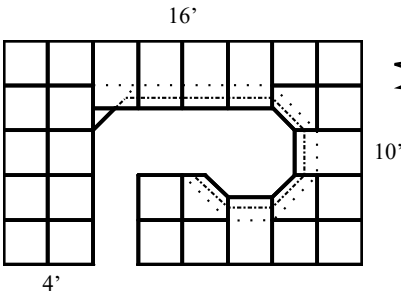

As low as
\$1799.00

Models WT1016-24.....\$1799.00
 WT1016-30.....1829.00
 WT1016-36.....1899.00
 4' x 10' x 16' x 40" high

Do you have a track plan or a room size that doesn't seem to work with our kits? No problem! Almost half of our business is layouts designed for an individual application. Best of all we do not charge anything extra for this service and even supply you with a color coded assembly drawing for your layout at no additional charge! It just doesn't get any easier than **MIANNE.**

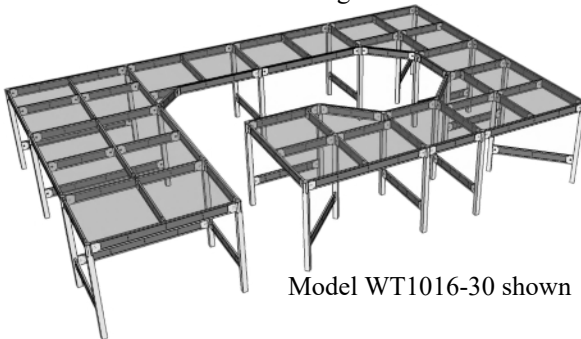

Model WT1016-30 shown

• • • Front edge of -24 model (24")
 - - - Front edge of -30 model (30")

As low as
\$1989.00

Model WT1216-36 shown

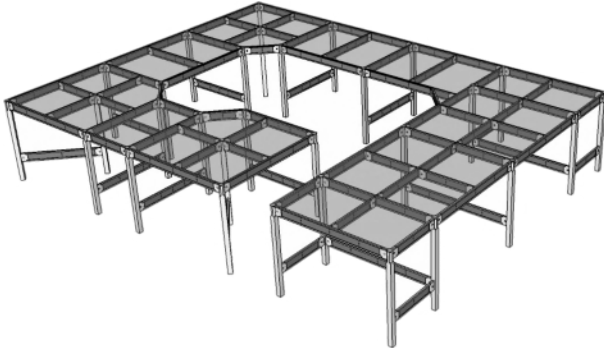

Models WT1216-24.....\$1989.00
 WT1216-30.....1999.00
 WT1216-36.....2019.00
 4' x 12' x 16' x40" high

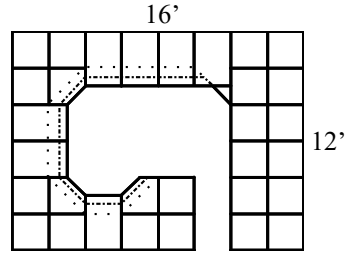

Models WT1216B-24.....\$1869.00
 WT1216B-30.....1889.00
 WT1216B-36.....1899.00
 4' x 12' x 16' x40" high

As low as
\$1869.00

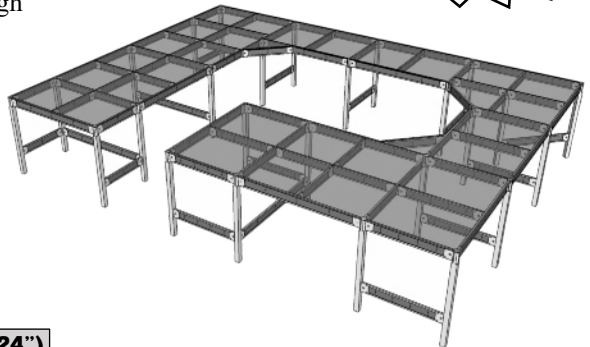
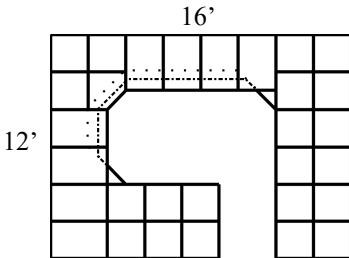

Model WT1216B-30 shown

· · · Front edge of -24 model (24")
 - - - Front edge of -30 model (30")

Still not sure?



Check out our ST-4x8 assembly video on YouTube and see for yourself how easy it is to build the best performing and best looking benchwork ever!

It covers everything from opening the box to installing the hardware for attaching the top. Please scan this code and watch. You'll be amazed how easy Mianne Benchwork is assembled and how quickly you'll be laying the track for your layout.



Around the Room Layouts

Are you looking to build a layout that features continuous running trains? These room filling kits may be just what you're looking for. Check out the chart below for a size that will work in your layout room. None of the sizes quite fit your area? Give us a call and we'll modify any kit so it will work in your home. Don't forget: All *MIANNE* kits and parts can be combined for unlimited layout design possibilities. Because *MIANNE* is changeable and expandable you can start at any size and add to your layout as time and budget permit.

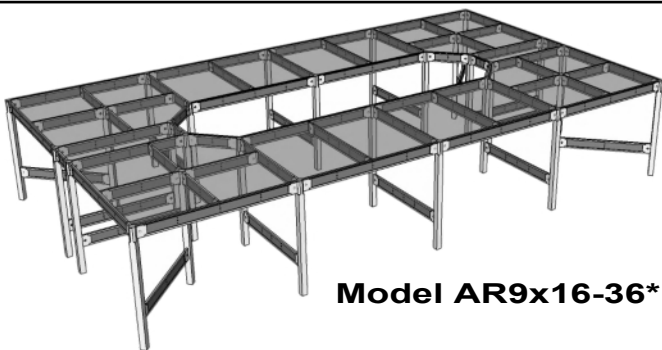

Model AR9x16-36*

All prices shown based on standard 40" height or lower

Size (Model #)	Price	Size (Model #)	Price	Size (Model #)	Price
AR8x12-24	\$1,249.00	AR9x16-30	\$1,719.00	AR10x24-36	\$2,349.00
AR8x12-30	\$1,269.00	AR9x16-36*	\$1,769.00	AR12x12-24	\$1,509.00
AR8x12-36	\$1,299.00	AR10x12-24	\$1,439.00	AR12x12-30	\$1,539.00
AR8x16-24	\$1,509.00	AR10x12-30	\$1,469.00	AR12x12-36	\$1,579.00
AR8x16-30	\$1,539.00	AR10x12-36	\$1,499.00	AR12x16-24	\$1,769.00
AR8x16-36	\$1,579.00	AR10x16-24	\$1,699.00	AR12x16-30	\$1,799.00
AR8x20-24	\$1,769.00	AR10x16-30	\$1,739.00	AR12x16-36	\$1,859.00
AR8x20-30	\$1,799.00	AR10x16-36	\$1,789.00	AR12x20-24	\$2,029.00
AR8x20-36	\$1,859.00	AR10x20-24	\$1,959.00	AR12x20-30	\$2,069.00
AR9x12-24	\$1,419.00	AR10x20-30	\$1,999.00	AR12x20-36	\$2,149.00
AR9x12-30	\$1,449.00	AR10x20-36	\$2,069.00	AR12x24-24	\$2,289.00
AR9x12-36	\$1,489.00	AR10x24-24	\$2,219.00	AR12x24-30	\$2,329.00
AR9x16-24	\$1,679.00	AR10x24-30	\$2,269.00	AR12x24-36	\$2,429.00

*Example: Model AR 9x16-36 is 9' x 16' with 36" depth on the long sides.

All above prices based on standard 40" height or lower

Did you see a layout plan in a magazine or plan book? Call us and we will quote you a price on a benchwork that will work with both the track plan and the area you have available in your home. There is never any need to waste time trying to figure out what you need, we can do it for you and insure you only buy what you really need! Another reason *MIANNE* is the best benchwork system anywhere!

Mianne Multi Deck

Bring Your Layout to a Whole New Level

Let **Mianne Multi-Deck Benchwork** add a whole new dimension to your dream layout. Now you can easily add an additional railroad without using more space in your home. Maybe a different scale or different era. How about that small logging railroad you always wanted but didn't fit in with your main layout plans. **Mianne Multi-Deck** is the perfect answer and can be added to any of our kits. Available in 3 depths: 12", 18" and 24". Cantilevered brackets come ready to install with all necessary hardware included. Any Mianne kit can be made "2nd level ready" just by using taller upper level legs where future expansion is planned for.

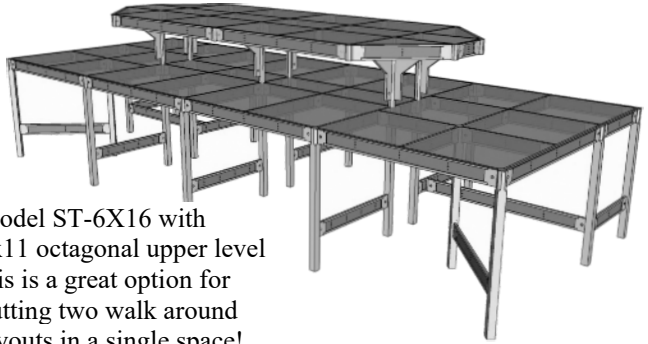

Model ST-6X16 with 4x11 octagonal upper level this is a great option for putting two walk around layouts in a single space!

Cantilevered design means no obstructions on main level.

Creates a great place to install lighting for main layout.

Solid one piece hardwood legs and finish plywood brackets for superior strength and stability.

Great for storage, test tracks or even another separate layout.

Same great quality and easy assembly **Mianne Benchwork** is famous for.

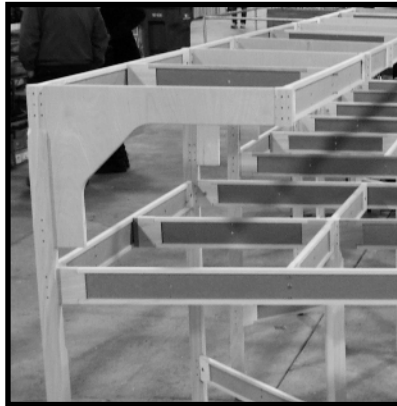

Existing **Mianne** layouts can be upgraded to multi-deck just by swapping out the legs in the section where the upper level is desired. Works with all **Mianne Benchwork** I-beams. Call today and we'll help you get started!

- Unique cantilevered design
- High quality hardwood plywood
- Increases layout space
- Upper level at 58" or 54"
- Can be added to any Mianne Benchwork kit
- Same quick and easy Mianne assembly
- More benchwork means more trains means more fun!

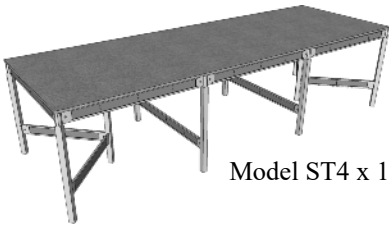

Model ST4 x 12

Most modelers are limited as to how much space is available for their layout. More often than not there is far less space available than is desired. By adding a second level an amazing amount of new space can be had.

For example our starter set model 4x12 has a total layout size of 48 square feet. By adding our 24" cantilevered upper level it's increased to 84 square feet, an increase of 75%. The amount of upper level layout can be customized to suit your needs.

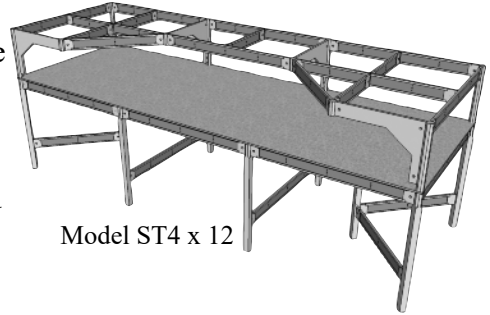

Model ST4 x 12

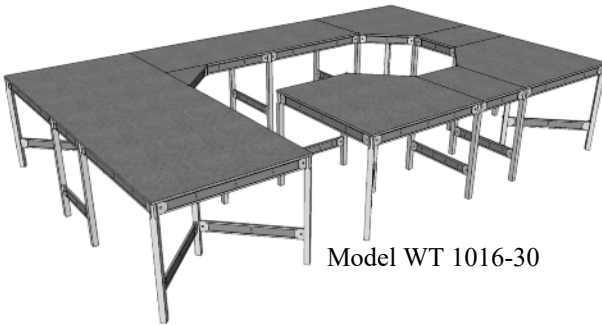

Model WT 1016-30

You may only want to add an upper level to part of your layout. No problem, with Mianne you never buy more than you need. In this example we have added a second level to our model WT1016-30 Walk-Thru kit.

Even this partial upper level adds 62 square feet, an addition of almost 2 full 4x8 layouts!

Individual Part Pricing is shown in the table below

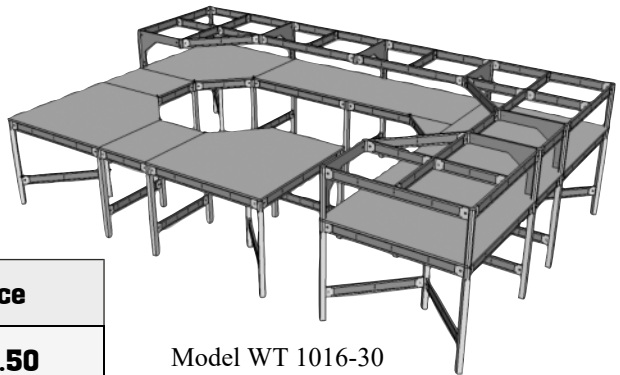

Model WT 1016-30

Part	Price
58" Leg	\$29.50
12" Bracket	22.00
18" Bracket	31.25
24" Bracket	31.25
Full Connector	5.75

For more information or a no obligation quote please write to us at miannebenchwork@gmail.com or call us at 508-226-1600 Mon-Fri 8am to 4:30pm eastern time.

Layouts shown with top for visual clarity (not included with kit)

Mianne Lift-Gate

Starting at
\$1029.00

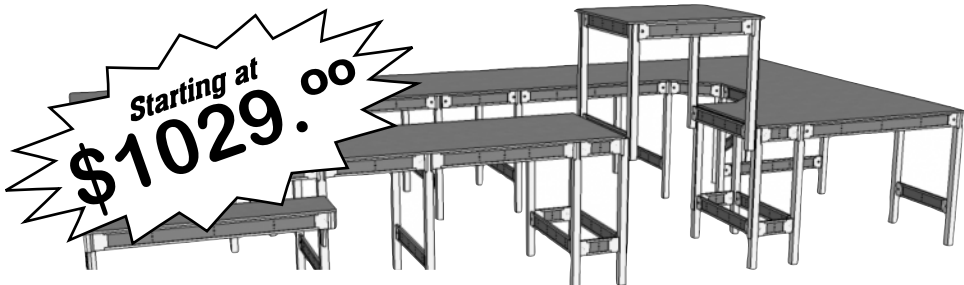

**The ultimate in
Convenience!**

Vertical lift design means full scenery capability with no unsightly scenic gap in your layout! Easily supports all of your track & scenery materials.

The MIANNE Lift-Gate comes as a ready to assemble kit to replace a 5' section or opening in the benchwork without any modifications necessary. Currently available in 24", 30" & 36" depths. All hardware necessary for assembly is included. Many other widths also available.

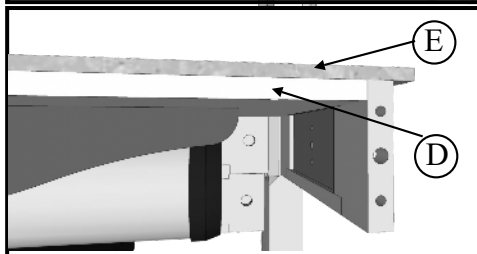
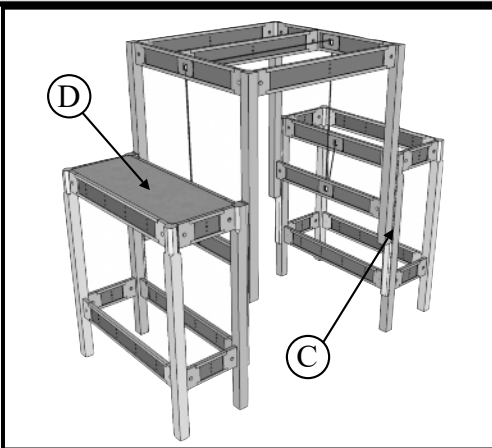
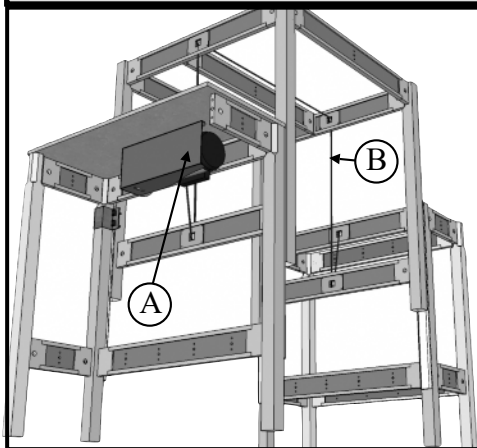

- A) Electric drive motor
- B) High strength stainless steel cable
- C) Precision ball bearing slides
- D) 3/4" Recessed plywood motor mount (not included)
- E) Layout top (not included)

Mianne Lift-Gate

Do you want to run long trains, have space for a yard and continuous running? Maybe you just want to avoid the dreaded crawl under? Then the MIANNE Lift-Gate may be just what you need.

Down Position

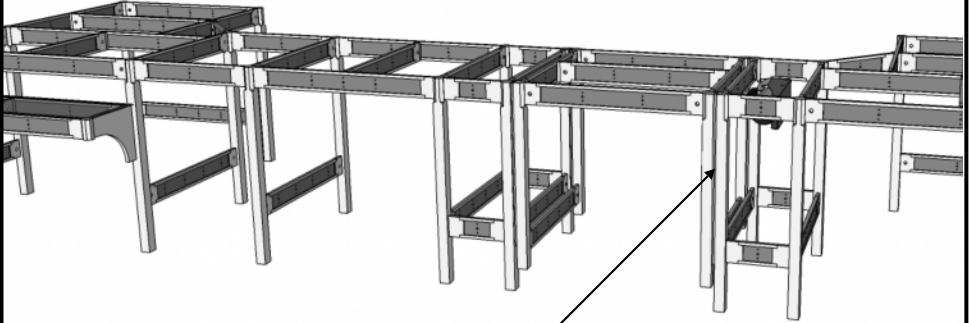

Precision ball bearing slides for years of reliability

Using our standard 40" height legs you will get 64" of clearance for getting to the interior of your layout. The MIANNE Lift-Gate can be incorporated into one of our kits, a custom design or even retro-fitted into an existing MIANNE layout.

Up Position

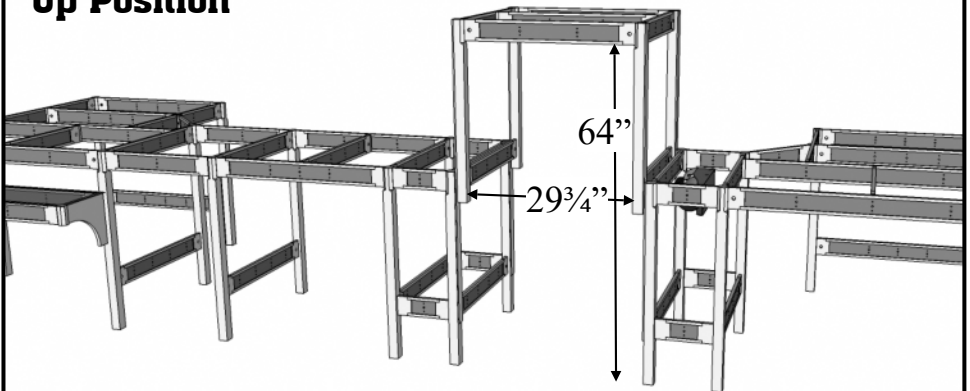

And, best of all, as always, the same easy assembly and great quality that MIANNE Benchwork is known for!

Mianne Lift-Gate

Already have a layout and it's not Mianne? No problem, our Lift-Gates can be used as free standing units, all you have to do is create an opening large enough for the lift gate and crawling under is a thing of the past!

Motor can be installed on either side

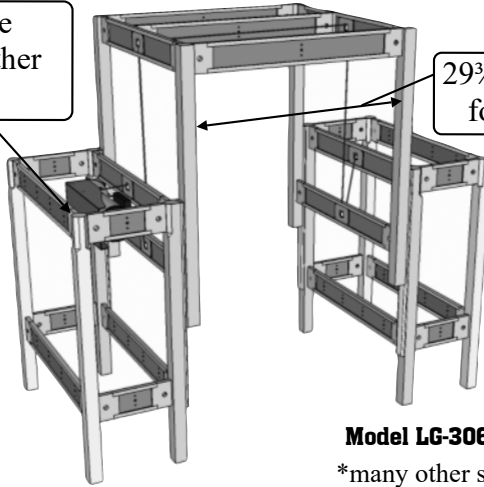

29³/₄" Wide opening for easy access*

Model LG-3060-FS shown \$1049.00

*many other sizes available with up to an amazing 41³/₄" wide opening

Requires 62" wide opening for installation

Including a turntable or transfer table in your layout that needs to be installed below grade? Mianne's adjustability will make this usually difficult task easy. Just let us know approximately where you want it located and we'll provide an adjustable section so you can locate it perfectly in your layout. Best of all, it's still stock Mianne, no extra custom charges. This is a great example of the convenience and flexibility that makes Mianne the best value in benchwork construction. Pre-fabricated or stick built, no benchwork construction method delivers like Mianne does!



Auto Indexing Precision Turntable provided by Mill River Studio
Visit them at <http://www.studiozphoto.com/millhouse.html>

Mianne Lift-Gate Ready Kits

Love the idea of a lift-gate for your layout but it's just not in the budget?

Lift-Gate Ready version
Model WT1216B-36

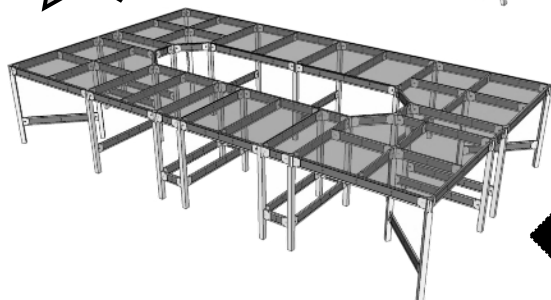
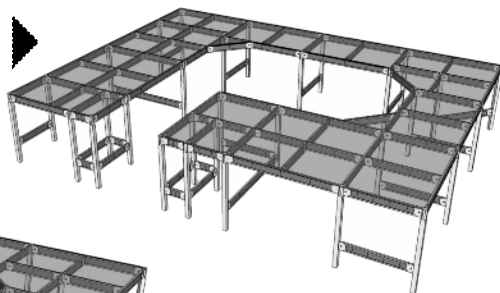

Lift-Gate Ready version
Model AR916-36

Many of our kits can be made "Lift-Gate Ready" to make adding the lift-gate easy at a later date. Here's just a couple of examples of our stock kits that are Modified to be "Lift-Gate Ready". You won't find this option anywhere else. ***Many kits, both stock and custom can be made "Lift-Gate Ready"***

Mianne Control Accessories

Don't want to waste valuable layout real estate for your transformers and accessory controllers? Try one or both of these excellent Mianne exclusives!

Mianne Transformer Shelf

\$129.00*

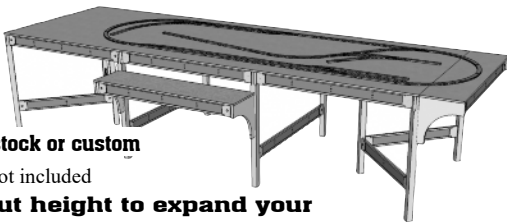

\$109 if ordered with any complete kit, stock or custom

*48"x12" shown, other sizes available, top not included

Can even be installed at layout height to expand your railroad empire without the need for additional legs

A Mianne Exclusive

\$139.00

• Price includes top and casters

36" x 12" x (30", 27" or 24")

High Rollaway Transformer Cart)

Custom sizes available

Easily stores under layout when not in use!



TC-3612

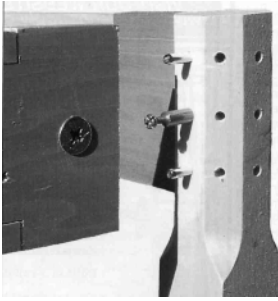

I-beams and legs lock together with a simple half turn of a screwdriver. You can assemble, change and reassemble in minutes, never having to cut anything. There are no permanent modules or sections, all pieces can interchange for different configurations at any time.

Mianne I-beams are constructed of a hardwood frame with an MDF* web for exceptional strength and dimensional stability as well as light weight that no solid wood can match. Pre-drilled holes allow for cross member attachment or for installing wiring. (30" I-beam shown)

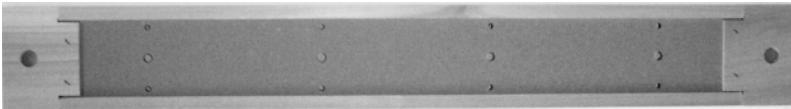

Legs are constructed from solid hardwood and include the unique **Mianne** multi-directional top with a fully adjustable leg leveling system built in. All mounting holes are accurately pre-drilled for easy frustration free assembly.

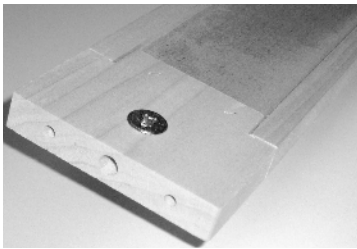

Quick lock cam fasteners are fast, strong and keep joints square for sturdy assembly. Pre-drilled mounting holes allow quick and precise attachment of **Mianne I-beams** for unlimited layout design.

*MDF — Medium Density Fiberboard: a composite construction material made from wood fibers glued under extreme heat and pressure.



Need a lowered section for a bridge or overpass scene? It's easy with Mianne, the possibilities are simple and endless!



Mianne Custom Layouts

Examples of customer layouts all using only stock MIANNE parts

5' x 7' overall



It doesn't matter how big or small an area you have for your layout. Designing your benchwork, finding good quality material and actually getting the benchwork built is not the easiest thing to accomplish (NO, those "premium" twisted 2x4's at the home center

are not a good idea). At *Mianne* we have designed and supplied hundreds of customers with better quality and better built benchwork than they would have ever built themselves.

Mianne can get you from just

7' x 10' overall

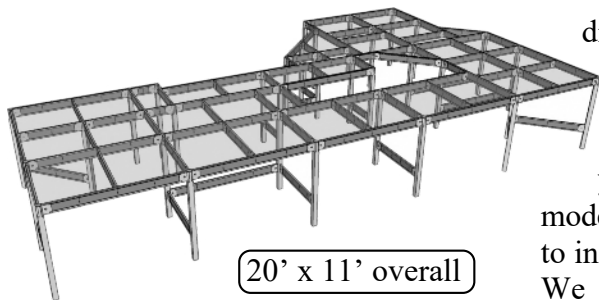
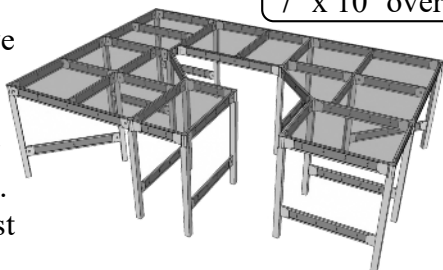

20' x 11' overall

dreaming about your layout to actually getting it built. All we need are some basic measurements of the area in your home, scale you are modeling and any features you want to incorporate into your track plan. We will provide you with a no obligation design and quote for your benchwork kit shipped right to

your home. If you have been putting off building your layout, it's time to stop just thinking about it.

Send us an email or give us a call. Running your trains is a whole lot better than just looking at them or worse just looking at the boxes they're in!

20' x 16' overall

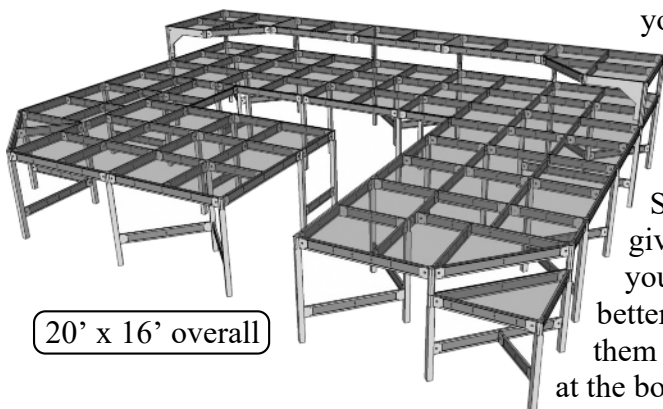

Frequently Asked Questions

1) Q. There doesn't seem to be a kit for the layout I want to build. What should I do?

A. Mianne Benchwork can be configured for any layout design. We offer a free, no obligation design service. You can either send us a track plan, room dimensions, or desired layout dimensions. We will then design a kit to work for you and quote you a price. The Mianne Benchwork system works in 6" increments for unlimited design possibilities. You can even combine different sizes for a truly custom layout. All kits, whether stock or custom, come with a detailed color-coded assembly plan for quick and easy assembly.

2) Q. How do I attach the layout to the benchwork?

A. We suggest attaching a 1/2" interior plywood platform for a base using the hardware included with your kit. This method will allow you to easily remove the layout from the benchwork at a later time. Anyone who has ever tried to change a layout or had to move a layout can appreciate this easy method.

3) Q. How do I attach risers for different track elevations?

A. After attaching your plywood base, you can easily add risers to the plywood for elevating track.

4) Q. What are connector blocks and adapter blocks?

A. Connectors are used to attach I-beams to other I-beams. Connectors allow attachment in three directions. Adapters are used as fillers for crosspiece attachment. See assembly instructions for diagrams.

5) Q. Can I purchase Mianne with a height different than the standard 40"?

A. Yes, we can make the height whatever you need. Just let us know when ordering.

6) Q. How is Mianne shipped?

A. We ship via standard UPS Ground Services. The largest box we ship in is 8"×8"×48" and usually weighs less than 50 lbs. (Kits with upper levels or brackets may require larger boxes)

7) Q. Can I purchase one section and add to it later on?

A. Yes. Try not to think of Mianne as modular but rather as a series of legs and I-beams that connect together to form one unitized structure. For example, if you wanted a 2'×4' section you would need to purchase a 24B expansion kit and a 24LS leg set. If you wanted a 2'×8' section you would need 2 24B sections but only one 24C. This benchwork would have six legs total.

8) Q. Why not just use solid wood for frame members instead of I-beams?

A. There are a few of reasons for utilizing a built up I-beam instead of solid wood.

1) Stability - every piece of wood is different and therefore reacts to seasonal changes differently. Our I-beams have a MDF core, with a hardwood frame. This creates consistent seasonal movement in all pieces. More stability equals more reliable trackwork and running of trains. In short: More Fun!

2) Consistency - the I-beams are produced on dedicated machines and are therefore consistent in tolerance. This makes for easy and reliable assembly.

3) Weight - we have achieved great strength with low weight. This makes for easy construction and helps keep shipping costs down. You'll appreciate it when your order arrives, that's for sure!

Popular Expansion Sections

Part #	Description	Price
24A	24" x 48" x 48" Corner	\$239.00
24B	24" x 48" Straight	131.00
24C	24" x 42" Straight	129.00
24D	24" x 36" Straight	124.00
24E	24" x 30" Straight	97.00
24F	24" x 24" Straight	96.00
24G	24" x 18" Straight	89.00
24H	24" x 12" Straight	87.00
24LS	24" Leg Set	70.00
30A	30" x 48" x 48" Corner	245.00
30B	30" x 48" Straight	135.00
30C	30" x 42" Straight	132.00
30D	30" x 36" Straight	126.00
30E	30" x 30" Straight	99.00
30F	30" x 24" Straight	97.00
30G	30" x 18" Straight	91.00
30H	30" x 12" Straight	89.00
30LS	30" Leg Set	73.00

*These are just some of our stock sizes, the possibilities are endless!
Don't see your size? Think in 6" increments and it's a stock size!
Only MIANNE gives you custom with no extra custom charges!*

Any size expansion section can be provided to expand your existing benchwork. Just give us a call and we will quote you a price for whatever you need! Let us do the figuring for you so you can spend more time on the fun stuff!

* Expansion Sections include legs but are not free-standing and are intended to be added onto an existing layout.
Please note: Above expansion prices are based on standard 40" height.

Mianne Parts List

All **Mianne** parts are available separately to make sure you only buy what you actually need. If you need help in determining exactly which parts you need please call us and we will be glad to help out. Legs are available in any height and custom length I-beams are also available upon request.

Item #	Description	Price (each)
0012	12" I-beam	10.00
0018	18" I-beam	11.00
0024	24" I-beam	14.50
0030	30" I-beam	15.50
0036	36" I-beam	18.50
0042	42" I-beam	21.25
0048	48" I-beam	22.00
1245	1245 (45°) I-beam	11.00
1845	1845 (45°) I-beam	14.50
2445	2445 (45°) I-beam	19.00
3045	3045 (45°) I-beam	21.50
1005	Connector Block	3.75
1010	Full Connector	5.75
2001	Adapter Block Assy	3.25
2002	Double Adapter Assy	5.75
3001	Top Attachment Block	0.65
1040	40" Leg	21.25
1048	42 - 48" Leg*	25.25
1058	58" 2 Level Leg*	29.50
CAS-1	2" Adjustable Height Caster (NL/L)	5.00/5.75

MIANNE Benchwork is shipped to you factory direct with no middle man. We ship via UPS ground services. The largest box we usually use is 8"x 8" x 48" and average weight is less than 50 lbs per box. No 100 plus pound boxes of lumber to carry, your back will thank you!

Please visit us on the web and send us any comments or questions you may have at www.miannebenchwork.com

Email to: miannebenchwork@gmail.com

* legs longer than 48" do require larger boxes and may also require additional shipping charges

Mianne Order Form

Call to Order: **508-226-1600** Mon-Fri 8am to 4:30pm Eastern Time

Fax Orders to: **508-226-1666** anytime

Item #	Quant ity	Description	Price (each)	Total

*Standard shipping is 12.5% on all orders \$200 or more. 18% on orders under \$200 (\$20.00 minimum). These rates apply only to the continental USA. AK, HI or Canada please call for quote. Standard shipping is via UPS Ground Services.

Subtotal		
6.25% Tax (MA only)		
Shipping*		
Total		

◆ Most hardware only orders shipped via UPS Ground Saver. \$11.00 minimum

Name (as it appears on credit card)

Shipping Address

City/ Town, State/ Province, Country, Zip/ Postal Code

Daytime Phone Alternate Phone

Billing Address (if different from shipping)

City/ Town, State/ Province, Country, Zip/ Postal Code

Circle One: **Mastercard** **Visa** **AMEX** **Discover** Expires (mm/yy)

Card Number: Security Code (CVV)

Email:

Cardholders Signature

If paying by check, please make payable to: Mianne Foley Woodworking

Mail or fax this form to: **Mianne Foley Woodworking Inc.**
44A Union Street
Attleboro, MA 02703-3154



Customizable Benches



Foley Woodworking Company

44A Union Street

Attleboro, MA 02703

508-226-1600 fax 508-226-1666 miannebenchwork@gmail.com

www.miannebenchwork.com